

THE ORANGE **KART**

2025
PRICE LIST
REV001

INDICE | INDEX

TELAI CHASSIS	1
CATEGORIE CATEGORIES	
RBS (OKJ - OK)-STR (KZ)	2
DD2-MONSTER EVO3	3
BABY-DARK EVO - AMERICA	4
ADESIVI & ACCESSORI MARCHIATI STICKER & BRANDED ITEMS	5
ABBIGLIAMENTO CLOTHING	6

I PREZZI DEL PRESENTE LISTINO AL PUBBLICO SONO DA INTENDERSI PER MERCE FRANCO NOSTRO STABILIMENTO DI SALIZZOLE (VR) E SONO RIFERITI UNICAMENTE AL MERCATO ITALIANO

THE PRICES QUOTED IN THIS PUBLIC PRICE LIST ARE ON EX-WORKS BASIS (SALIZZOLE / VR - ITALY) AND THEY'RE ONLY REFERRED TO THE ITALIAN MARKET

TELAI | CHASSIS

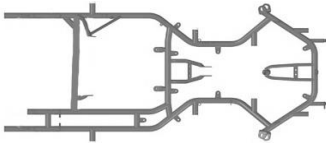
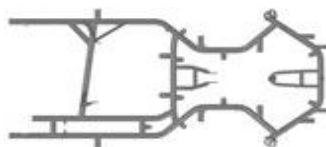
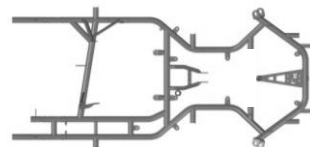
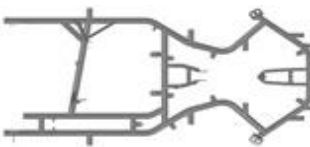
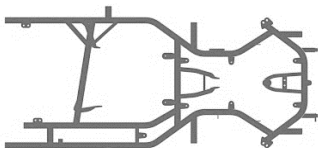
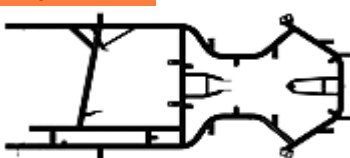
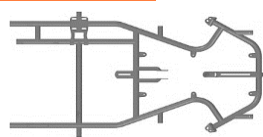
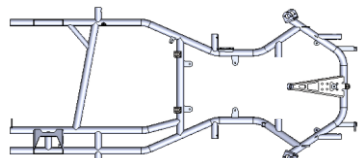
TELAI CHASSIS													
DRAGON EVO 3 XS1		<table border="1"> <tr><td>A</td><td>1045 mm</td></tr> <tr><td>A (DD2)</td><td>1045 mm</td></tr> <tr><td>B1</td><td rowspan="6" style="text-align: center; vertical-align: middle;">∅ 30 mm</td></tr> <tr><td>B2</td></tr> <tr><td>B3</td></tr> <tr><td>B4</td></tr> <tr><td>B5</td></tr> <tr><td>B6</td></tr> </table>	A	1045 mm	A (DD2)	1045 mm	B1	∅ 30 mm	B2	B3	B4	B5	B6
A	1045 mm												
A (DD2)	1045 mm												
B1	∅ 30 mm												
B2													
B3													
B4													
B5													
B6													
DRAGON EVO 3 XS3		<table border="1"> <tr><td>A</td><td>1045 mm</td></tr> <tr><td>B1</td><td rowspan="6" style="text-align: center; vertical-align: middle;">∅ 30 mm</td></tr> <tr><td>B2</td></tr> <tr><td>B3</td></tr> <tr><td>B4</td></tr> <tr><td>B5</td></tr> <tr><td>B6</td></tr> </table>	A	1045 mm	B1	∅ 30 mm	B2	B3	B4	B5	B6		
A	1045 mm												
B1	∅ 30 mm												
B2													
B3													
B4													
B5													
B6													
FIGHTER XS1		<table border="1"> <tr><td>A</td><td>1045</td></tr> <tr><td>B1</td><td rowspan="3" style="text-align: center; vertical-align: middle;">∅ 30 mm</td></tr> <tr><td>B2</td></tr> <tr><td>B3</td></tr> <tr><td>B4</td><td rowspan="3" style="text-align: center; vertical-align: middle;">∅ 32 mm</td></tr> <tr><td>B5</td></tr> <tr><td>B6</td></tr> </table>	A	1045	B1	∅ 30 mm	B2	B3	B4	∅ 32 mm	B5	B6	
A	1045												
B1	∅ 30 mm												
B2													
B3													
B4	∅ 32 mm												
B5													
B6													
FIGHTER XS3		<table border="1"> <tr><td>A</td><td>1045</td></tr> <tr><td>B1</td><td rowspan="3" style="text-align: center; vertical-align: middle;">∅ 30 mm</td></tr> <tr><td>B2</td></tr> <tr><td>B3</td></tr> <tr><td>B4</td><td rowspan="3" style="text-align: center; vertical-align: middle;">∅ 32 mm</td></tr> <tr><td>B5</td></tr> <tr><td>B6</td></tr> </table>	A	1045	B1	∅ 30 mm	B2	B3	B4	∅ 32 mm	B5	B6	
A	1045												
B1	∅ 30 mm												
B2													
B3													
B4	∅ 32 mm												
B5													
B6													
MONSTER EVO 3		<table border="1"> <tr><td>A (vers. MK950)</td><td>950 mm</td></tr> <tr><td>B1</td><td rowspan="6" style="text-align: center; vertical-align: middle;">∅28 mm</td></tr> <tr><td>B2</td></tr> <tr><td>B3</td></tr> <tr><td>B4</td></tr> <tr><td>B5</td></tr> <tr><td>B6</td></tr> </table>	A (vers. MK950)	950 mm	B1	∅28 mm	B2	B3	B4	B5	B6		
A (vers. MK950)	950 mm												
B1	∅28 mm												
B2													
B3													
B4													
B5													
B6													
DARK EVO		<table border="1"> <tr><td>A</td><td>1050 mm</td></tr> <tr><td>B1</td><td rowspan="6" style="text-align: center; vertical-align: middle;">∅30 mm</td></tr> <tr><td>B2</td></tr> <tr><td>B3</td></tr> <tr><td>B4</td></tr> <tr><td>B5</td></tr> <tr><td>B6</td></tr> </table>	A	1050 mm	B1	∅30 mm	B2	B3	B4	B5	B6		
A	1050 mm												
B1	∅30 mm												
B2													
B3													
B4													
B5													
B6													
BABY		<table border="1"> <tr><td>A</td><td>800 mm</td></tr> <tr><td>B1</td><td rowspan="6" style="text-align: center; vertical-align: middle;">∅28 mm</td></tr> <tr><td>B2</td></tr> <tr><td>B3</td></tr> <tr><td>B4</td></tr> <tr><td>B5</td></tr> <tr><td>B6</td></tr> </table>	A	800 mm	B1	∅28 mm	B2	B3	B4	B5	B6		
A	800 mm												
B1	∅28 mm												
B2													
B3													
B4													
B5													
B6													
AMERICA		<table border="1"> <tr><td>A</td><td>1035 mm</td></tr> <tr><td>B1</td><td rowspan="6" style="text-align: center; vertical-align: middle;">∅30 mm</td></tr> <tr><td>B2</td></tr> <tr><td>B3</td></tr> <tr><td>B4</td></tr> <tr><td>B5</td></tr> <tr><td>B6</td></tr> </table>	A	1035 mm	B1	∅30 mm	B2	B3	B4	B5	B6		
A	1035 mm												
B1	∅30 mm												
B2													
B3													
B4													
B5													
B6													

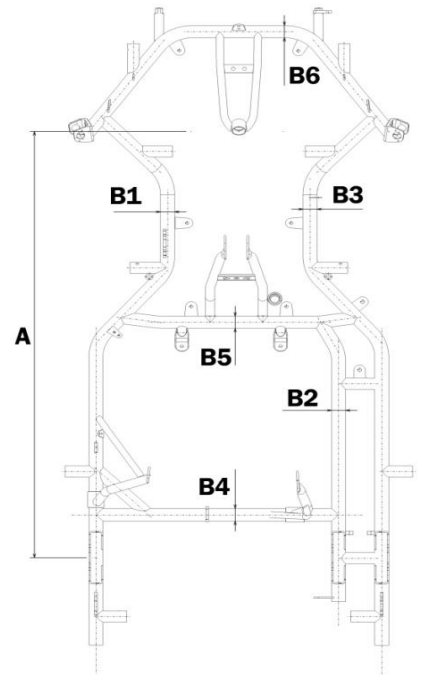

RBS - OK, OKJ

	Impianto freno brake system	idraulico modello RBS.V3 <i>hydraulic RBS.V3 model</i>
	Disco freno brake disc	posteriore autoventilato flottante <i>ventilated floating rear brake disc</i>
	Assale axle	Assale Ø50X2X1030MM MOD.MR (dotazione standard) <i>axle Ø50X2X1030MM MOD.MR (standard equipment)</i>
	Carenature bodyworks	modello 507/509 con supporti omologati CIK-FIA <i>507/509 with CIK-FIA homologated supports</i>
	Cerchi wheel rims	DWT serie "V" in magnesio, 132 mm ant. - 212 mm post. <i>DWT "V" series, magnesium, 132 mm front - 212 mm rear</i>
	Serbatoio fuel tank	8.5 L
	Fuselli spindles	Ø25 mm
	Volante steering wheel	Volante "M6" <i>"M6" R steering wheel</i>

Descrizione <i>description</i>	Codice telaio <i>chassis code</i>	Prezzo (IVA esc.) <i>price (excl. VAT)</i>
OK1 DRAGON EVO3 XS3 RBS	OK1-DRGXS3E3RBS	€ 4.050,00
OK1 FIGHTER XS3 RBS	OK1-FGHXS3RBS	
OK1 DRAGON EVO3 XS3 RBS MAGNESIUM	OK1-DRGXS3E3RBSMG	€ 4.430,00
OK1 FIGHTER XS3 RBS MAGNESIUM	OK1-FGHXS3RBSMG	
OK1 DRAGON EVO3 XS3 RBS (Rotax)	OK1-DRGXS3E3RBSRTX	€ 4.065,00
OK1 FIGHTER XS3 RBS (Rotax)	OK1-FGHXS3RBSRTX	
OK1 DRAGON EVO3 XS3 RBS MG. (Rotax)	OK1-DRGXS3E3RBSMGRTX	€ 4.445,00
OK1 FIGHTER XS3 RBS MG. (Rotax)	OK1-FGHXS3RBSMGRTX	
*SEDILO MOD. "RACING" INCLUSO / *MODEL "RACING" SEAT INCLUDED		

Scocca OK1 Dragon Evo3 XS3 OK1 Dragon Evo3 XS3 frame	OK1-FRA-DRGXS3E3	€ 1.390,00
Scocca OK1 Fighter XS3 OK1 Fighter XS3 frame	OK1-FRA-FGHXS3	

STR - KZ

	Impianto freno brake system	idraulico modello STR.V2 <i>hydraulic STR.V2 model</i>
	Disco freno brake disc	autoventilati flottanti <i>ventilated floating discs</i>
	Assale axle	Assale Ø50X2X1030MM MOD.MR (dotazione standard) <i>Axle Ø50X2X1030MM MOD.MR (standard equipment)</i>
	Carenature bodyworks	modello 507/509 con supporti omologati CIK-FIA <i>507/509 with CIK-FIA homologated supports</i>
	Cerchi wheel rims	DWT serie "V" in magnesio, 132 mm ant. - 212 mm post. <i>DWT "V" series, magnesium, 132 mm front - 212 mm rear</i>
	Serbatoio fuel tank	8.5 L
	Fuselli spindles	Ø25 mm
	Volante steering wheel	Volante "M6" <i>"M6" R steering wheel</i>

Descrizione <i>description</i>	Codice telaio <i>chassis code</i>	Prezzo (IVA esc.) <i>price (excl. VAT)</i>
OK1 DRAGON EVO3 XS1 STR	OK1-DRGXS1E3STR	€ 5.000,00
OK1 FIGHTER XS1 STR	OK1-FGHXS1STR	
OK1 DRAGON EVO3 XS1 STR MAGNESIUM	OK1-DRGXS1E3STRMG	€ 5.400,00
OK1 FIGHTER XS1 STR MAGNESIUM	OK1-FGHXS1STRMG	
*SEDILO MOD. "RACING" INCLUSO / *MODEL "RACING" SEAT INCLUDED		

Scocca OK1 Dragon Evo3 XS1 OK1 Dragon Evo3 XS1 frame	OK1-FRA-DRGXS1E3	€ 1.390,00
Scocca OK1 Fighter XS1 OK1 Fighter XS1 frame	OK1-FRA-FGHXS1	

DD2

	Impianto freno brake system	idraulico modello STR.V2 <i>hydraulic STR.V2 model</i>
	Disco freno brake disc	autoventilati flottanti <i>ventilated floating discs</i>
	Assale axle	Assale Ø40X3X1040MM MOD.M (dotazione standard) <i>axle Ø40X3X1040MM MOD.M (standard equipment)</i>
	Carenature bodyworks	modello 507/509 con supporti omologati CIK-FIA <i>507/509 with CIK-FIA homologated supports</i>
	Cerchi wheel rims	DWT serie "V" in magnesio, 132 mm ant. - 212 mm post. <i>DWT "V" series, magnesium, 132 mm front - 212 mm rear</i>
	Serbatoio fuel tank	8.5 L
	Fuselli spindles	Ø25 mm
	Volante steering wheel	Volante "M6" <i>"M6" R steering wheel</i>

Descrizione <i>description</i>	Codice <i>chassis</i>	Prezzo (IVA esc.) <i>price (excl. VAT)</i>
OK1 DRAGON EVO3 DD2	OK1-DRGE3DD2	€ 4.870,00
OK1 FIGHTER DD2	OK1-FGHDD2	
<i>*SEBILE MOD. "RACING" INCLUSO / *MODEL "RACING" SEAT INCLUDED</i>		
<i>Scocca OK1 Dragon Evo3 DD2</i> <i>OK1 Dragon Evo3 DD2 frame</i>	OK1-FRA-DRGDD2E3	€ 1.390,00
<i>Scocca OK1 Fighter DD2</i> <i>OK1 Fighter DD2 frame</i>	OK1-FRA-FGHDD2	

MONSTER EVO 3

	Impianto freno brake system	idraulico modello MKB.V2 <i>hydraulic MKB.V2 model</i>
	Disco freno brake disc	posteriore autoventilato flottante da Ø149 mm <i>ventilated floating Ø149 mm rear brake disc</i>
	Assale axle	Assale Ø30X5X960MM MOD.M (dotazione standard) <i>axle Ø30X5X960MM MOD.M (standard equipment)</i>
	Carenature bodyworks	modello MK20/27 con supporti omologati CIK-FIA <i>MK20/27 with CIK-FIA homologated supports</i>
	Cerchi wheel rims	IPK in alluminio, 109 mm anteriori - 146 mm posteriori <i>IPK aluminum, 109 mm front - 146 mm rear</i>
	Serbatoio fuel tank	4.5 L
	Fuselli spindles	Ø17mm
	Volante steering wheel	Volante "M6" <i>"M6" R steering wheel</i>

Descrizione <i>description</i>	Codice telaio <i>chassis code</i>	Prezzo (IVA esc.) <i>price (excl. VAT)</i>
OK1 MONSTER EVO3 MINIKART <i>passo wheelbase 950 - assale axle Ø30</i>	OK1MK-9530E3-S	€ 2.690,00
OK1 MONSTER EVO3 MINIKART USA <i>passo wheelbase 950 - assale axle Ø30 wheel rims 130</i> <i>LV front hubs Ø17x50mm</i>	OK1MK-9530E3-USA	€ 2.864,00
<i>*SEBILE MOD. "RACING" INCLUSO / *MODEL "RACING" SEAT INCLUDED</i>		
<i>Scocca OK1 Monster Evo3 950 (006-CH-15)</i> <i>OK1 Monster Evo3 950 frame (006-CH-15)</i>	FRA-OK1MK950E3	€ 1.045,00

BABY



Impianto freno brake system	meccanico <i>mechanical</i>
Disco freno brake disc	posteriore da Ø155 mm <i>Ø155 mm rear brake disc</i>
Assale axle	Assale Ø30X960MM <i>axle Ø30X960MM MOD.M</i>
Carenature bodyworks	modello MK14 con supporti omologati CIK-FIA <i>MK14 with CIK-FIA homologated supports</i>
Cerchi wheel rims	IPK in alluminio, 109 mm anteriori - 146 mm posteriori <i>IPK aluminum, 109 mm front - 146 mm rear</i>
Motore engine	Modello Honda GX35 o modello 140F 35cc <i>Honda GX35 model or 140F 35cc model</i>
Fuselli spindles	Ø17 mm

Descrizione <i>description</i>		Codice telaio <i>chassis code</i>	Prezzo (IVA esc.) <i>price (excl. VAT)</i>
OK1 BABY	<i>senza motore e gomme pre-assemblato without engine and tyres pre-assembled</i>	BBY-800NK-OK1	€ 2.260,00
OK1 BABY USA <i>rims 130 LV front hubs Ø17x50mm</i>	<i>senza motore e gomme pre-assemblato without engine and tyres pre-assembled</i>	OK1BBY-800NK-USA	€ 2.440,00

Scocca OK1 Baby OK1 Baby frame	FRA-BBY-OK1	€ 879,00
---	--------------------	-----------------

Motore 35cc. 140F + piastra di fissaggio 140F 35cc engine + fixing plate	KIT-ENG-140F	€ 245,00	net price
---	---------------------	-----------------	------------------

Set pneumatici Baby 10X4.50-5/11X6.00-5 Baby tyres set 10X4.50-5/11X6.00-5	SET-TYBBY	€ 110,00	net price
---	------------------	-----------------	------------------

DARK EVO



Impianto freno brake system	idraulico <i>hydraulic</i>
Disco freno brake disc	posteriore autoventilato flottante da Ø195 mm <i>ventilated floating Ø195 mm rear brake disc</i>
Assale axle	Assale Ø50X2X1030MM MOD.MR (dotazione standard) <i>axle Ø50X2X1030MM MOD.MR (standard equipment)</i>
Carenature bodyworks	modello 507 con supporti omologati CIK-FIA <i>507 with CIK-FIA homologated supports</i>
Cerchi wheel rims	in alluminio, 130 mm anteriore - 210 mm posteriore <i>aluminum, 130 mm front - 210 mm rear</i>
Serbatoio fuel tank	8.5 L
Fuselli spindles	Ø25 mm

Descrizione <i>description</i>	Codice telaio <i>chassis code</i>	Prezzo (IVA esc.) <i>price (excl. VAT)</i>
OK1 DARK EVO	DARKE-OK1-PL-S	€ 2.695,00
*SEDILE MOD. "F6" INCLUSO / *MODEL "F6" SEAT INCLUDED		

Scocca OK1 Dark OK1 Dark frame	FRA-DRK-OK1	€ 1.245,00
---	--------------------	-------------------

AMERICA



Impianto freno brake system	idraulico <i>hydraulic</i>
Disco freno brake disc	posteriore Ø162 mm in acciaio <i>Ø162mm steel rear</i>
Assale axle	Assale Ø40X3X980MM MOD.M (dotazione standard) <i>axle Ø40X3X980MM MOD.M (standard equipment)</i>
Carenature bodyworks	modello 507/509 con supporti omologati CIK-FIA <i>507/509 with CIK-FIA homologated supports</i>
Cerchi wheel rims	DWT "V" in magnesio, 132 mm ant. - "LV" 180 mm post. <i>DWT "V", magnesium, 132 mm front - "LV" 180 mm rear</i>
Serbatoio fuel tank	8.5 L
Fuselli spindles	Ø25 mm

Descrizione <i>description</i>	Codice <i>chassis</i>	Prezzo (IVA esc.) <i>price (excl. VAT)</i>
OK1 AMERICA	OK1-AMR	€ 3.800,00
*SEDILE MOD. "RACING" INCLUSO / *MODEL "RACING" SEAT INCLUDED		





Scocca OK1 America OK1 America frame	OK1-FRA-AMR	€ 1.345,00
---	--------------------	-------------------

ADESIVI & ACCESSORI MARCHIATI | STICKER & BRANDED ITEMS

	Codice code	Descrizione description	Prezzo (IVA escl.) price (excl. VAT)
	STK-FLPRCN-IPK	ADESIVO PIANALE RACING IPK IPK RACING FLOOR PLATE STICKER	€ 48,00
	STK-FLPRCN-IPK	ADESIVO PIANALE MINIKART IPK IPK MINIKART FLOOR PLATE STICKER	€ 48,00
	STK-KIT509-OK125	KIT ADESIVI MOD. 509 + SPOILER POST. E SERBATOIO 8.5L OK1 OK1 BODYWORKS + REAR SPOILER & TANK STICKERS KIT MOD. 509	€ 157,00
	STK-KITMK27-OK125	KIT ADESIVI CARENATURE MOD. MK27 + SERBATOIO OK1 OK1 BODYWORKS + TANK STICKERS KIT MOD. MK27	€ 147,00
	STK-KITMK14-OK1BBY25	KIT ADESIVI CARENATURE MOD. BABY OK1 OK1 KIT MOD. BABY BODYWORKS	€ 133,00
	STK-FS509-OK125	ADESIVO SPOILER ANTERIORE MOD. 509 OK1 OK1 FRONT SPOILER MOD. 509 STICKER	€ 68,00
	STK-FSMK27-OK125	ADESIVO SPOILER ANTERIORE MOD. MK27 OK1 (10 Pz) OK1 FRONT SPOILER MOD. MK27 STICKER (10 Pcs)	€ 54,00
		KIT-STK-RRSPSP	KIT ADESIVO UNIVERSALE PARTE ESTERNA SPOILER POST. (10 Pz.) UNIVERSAL REAR SPOILER SIDE PART STICKER KIT (10 Pcs.)
	STK-KIT507-OK1DRK25	KIT ADESIVI CARENATURE MOD. 507 OK1 DARK OK1 DARK STICKERS KIT MOD. 507 BODYWORKS	€ 133,00
	STR-WHLM6-OK1	VOLANTE "M6" OK1 IMPUGNATURA OVALE OK1 "M6" STEERING WHEEL OVAL HANDLE	€ 149,00
	DIAMETRO DIAMETER	330 mm	
	CHR-OK1	POLTRONA ERGONOMICA OK1 OK1 ERGONOMIC SEAT	€ 279,00
			<i>net price</i>
	TRK-KC-OK1	TELO COPRIKART OK1 OK1 KART COVER	€ 49,00
			<i>net price</i>
STK-TAP-IPK	NASTRO ADESIVO IPK SCOTCH TAPE IPK	€ 6,00	
SPY-VRN	BOMBOLETTA VERNICE "NERO" "BLACK" SPRAY PAINT	€ 22,00	
SPY-VR-OK1/RS	BOMBOLETTA VERNICE "OK1/RS" "OK1/RS" SPRAY PAINT	€ 22,00	
		<i>net price</i>	

ABBIGLIAMENTO | CLOTHING

	Codice <i>code</i>	Descrizione <i>description</i>	Prezzo netto <i>net price</i>
	DRS-TS-OK125	T-SHIRT OK1 TAGLIA da XXS a XXL <i>OK1 T-SHIRT SIZE from XXS to XXL</i>	€ 25,00
	DRS-HD-OK125	FELPA OK1 TAGLIA da XXS a XXL <i>OK1 HOODIE SIZE from XXS to XXL</i>	€ 69,00
	DRS-SFVXS-OK1	GILET OK1 TAGLIA XS <i>OK1 SOFTSHELL GILET SIZE XS</i>	€ 29,00
		GILET OK1 TAGLIA S <i>OK1 SOFTSHELL GILET SIZE S</i>	
		GILET OK1 TAGLIA M <i>OK1 SOFTSHELL GILET SIZE M</i>	
		GILET OK1 TAGLIA L <i>OK1 SOFTSHELL GILET SIZE L</i>	
		GILET OK1 TAGLIA XL <i>OK1 SOFTSHELL GILET SIZE XL</i>	
		GILET OK1 TAGLIA XXL <i>OK1 SOFTSHELL GILET SIZE XXL</i>	
	DRS-SFJ-OK1	GIACCA ESTIVA OK1 TAGLIA XS <i>OK1 SOFTSHELL JACKET SIZE XS</i>	€ 39,00
		GIACCA ESTIVA OK1 TAGLIA S <i>OK1 SOFTSHELL JACKET SIZE S</i>	
		GIACCA ESTIVA OK1 TAGLIA M <i>OK1 SOFTSHELL JACKET SIZE M</i>	
		GIACCA ESTIVA OK1 TAGLIA L <i>OK1 SOFTSHELL JACKET SIZE L</i>	
		GIACCA ESTIVA OK1 TAGLIA XL <i>OK1 SOFTSHELL JACKET SIZE XL</i>	
		GIACCA ESTIVA OK1 TAGLIA XXL <i>OK1 SOFTSHELL JACKET SIZE XXL</i>	
	DRS-WJ-OK1	GIACCA INVERNALE OK1 TAGLIA XS <i>OK1 WINTER JACKET SIZE XS</i>	€ 59,00
		GIACCA INVERNALE OK1 TAGLIA S <i>OK1 WINTER JACKET SIZE S</i>	
		GIACCA INVERNALE OK1 TAGLIA M <i>OK1 WINTER JACKET SIZE M</i>	
		GIACCA INVERNALE OK1 TAGLIA L <i>OK1 WINTER JACKET SIZE L</i>	
		GIACCA INVERNALE OK1 TAGLIA XL <i>OK1 WINTER JACKET SIZE XL</i>	
		GIACCA INVERNALE OK1 TAGLIA XXL <i>OK1 WINTER JACKET SIZE XXL</i>	
	DRS-SPNT-OK1	PANTALONI CORTI IPK TAGLIA XS <i>IPK SHORT PANTS SIZE XS</i>	€ 49,00
		PANTALONI CORTI IPK TAGLIA S <i>IPK SHORT PANTS SIZE S</i>	
		PANTALONI CORTI IPK TAGLIA M <i>IPK SHORT PANTS SIZE M</i>	
		PANTALONI CORTI IPK TAGLIA L <i>IPK SHORT PANTS SIZE L</i>	
		PANTALONI CORTI IPK TAGLIA XL <i>IPK SHORT PANTS SIZE XL</i>	
		PANTALONI CORTI IPK TAGLIA XXL <i>IPK SHORT PANTS SIZE XXL</i>	

	DRS-MPNT-OK1	PANTALONI OK1 TAGLIA XS OK1 PANTS SIZE XS	€ 29,00
		PANTALONI OK1 TAGLIA S OK1 PANTS SIZE S	
		PANTALONI OK1 TAGLIA M OK1 PANTS SIZE M	
		PANTALONI OK1 TAGLIA L OK1 PANTS SIZE L	
		PANTALONI OK1 TAGLIA XL OK1 PANTS SIZE XL	
		PANTALONI OK1 TAGLIA XXL OK1 PANTS SIZE XXL	
 <p>PHOTO COMING SOON</p>	DRS-CAP20-OK1	CAPPELLINO OK1 OK1 CAP	€ 13,00
	DRS-WCAP-OK1	CAPPELLINO INVERNALE OK1 OK1 WINTER CUP	€ 13,00
	DRS-SHKSA-OK124	SCARPE OMP KS-ART OK1 MISURA da 32 a 48 OK1 OMP KS-ART SHOES SIZE from 32 to 48	€ 289,00
	DRS-GLKSA-OK124	GUANTI OMP KS-ART OK1 MISURA XXXXS (tg4) OK1 OMP KS-ART GLOVES SIZE XXXXS (size4)	€ 159,00
		GUANTI OMP KS-ART OK1 MISURA XXXS (tg5) OK1 OMP KS-ART GLOVES SIZE XXXS (size5)	
		GUANTI OMP KS-ART OK1 MISURA XXS (tg6) OK1 OMP KS-ART GLOVES SIZE XXS (size6)	
		GUANTI OMP KS-ART OK1 MISURA XS OK1 OMP KS-ART GLOVES SIZE XS	
		GUANTI OMP KS-ART OK1 MISURA XS OK1 OMP KS-ART GLOVES SIZE XS	
		GUANTI OMP KS-ART OK1 MISURA S OK1 OMP KS-ART GLOVES SIZE S	
		GUANTI OMP KS-ART OK1 MISURA M OK1 OMP KS-ART GLOVES SIZE M	
		GUANTI OMP KS-ART OK1 MISURA L OK1 OMP KS-ART GLOVES SIZE L	
		GUANTI OMP KS-ART OK1 MISURA XL OK1 OMP KS-ART GLOVES SIZE XL	
		DRS-SUIT-OK124	
		TUTA PILOTA OK1 H130cm OK1 DRIVER SUIT H130cm	
		TUTA PILOTA OK1 H140cm OK1 DRIVER SUIT H140cm	
		TUTA PILOTA OK1 H150cm OK1 DRIVER SUIT H150cm	
		TUTA PILOTA OK1 H160cm OK1 DRIVER SUIT H160cm	
		TUTA PILOTA OK1 TAGLIA 44 OK1 DRIVER SUIT SIZE 44	
		TUTA PILOTA OK1 TAGLIA 46 OK1 DRIVER SUIT SIZE 46	
		TUTA PILOTA OK1 TAGLIA 48 OK1 DRIVER SUIT SIZE 48	
		TUTA PILOTA OK1 TAGLIA 50 OK1 DRIVER SUIT SIZE 50	
		TUTA PILOTA OK1 TAGLIA 52 OK1 DRIVER SUIT SIZE 52	
		TUTA PILOTA OK1 TAGLIA 54 OK1 DRIVER SUIT SIZE 54	
		TUTA PILOTA OK1 TAGLIA 56 OK1 DRIVER SUIT SIZE 56	
		TUTA PILOTA OK1 TAGLIA 58 OK1 DRIVER SUIT SIZE 58	
		TUTA PILOTA OK1 TAGLIA 60 OK1 DRIVER SUIT SIZE 60	
DRS-SUITCUS-OK124		TUTA OK1 PERSONALIZZATA OK1 CUSTOMIZED SUIT	€ 460,00
DRS-SUITCT-OK124	TUTA OK1 PERSONALIZZATA SU MISURA OK1 CUSTOMIZED TAILORED SUIT	€ 499,00	
DRS-SUITLOGO	LOGO SPONSOR SPONSOR LOGO	€ 25,00	